

ECO FENCING



INSTALLATION GUIDE

Issue 5

CONTENTS

Storage and handling	2
Safety and Use	2
Tools	3
Pre installation information	3
Cleaning and care	4
Installation method	4
Assembled fence heights	5
Fencing components	6
Planning your project	7
Installation	8

If in doubt at any stage

Please contact our Customer Care Team
for additional support or advice

 **0333 321 2353**

eurocell

STORAGE AND HANDLING

Whilst our composite materials are highly durable we do recommended you follow the below guidelines for storage, handling and installation, to ensure products are kept in the best possible condition.

STORAGE

- ▶ Materials should be covered and kept dry until ready to install to ensure a clean surface. Products should not be stored outside and or covered with plastic sheeting.
- ▶ All composite products should be stored supported above the ground at 500mm intervals on a flat clean surface. Supporting battens used in storage should align through the stack to equally transfer the load.
- ▶ Fencing panels must be stacked on top of each other.
- ▶ Where multiple pallets are delivered these should not be stacked higher than 3m per stack.
- ▶ Eurocell will not be held responsible for issues that arise from poor storage or handling.
- ▶ Watermarks may appear on panels, this will fade with time and add a weathered look to the board.

HANDLING

- ▶ Fencing boards should be lifted and set down with care to avoid damage. Do not slide boards over one another.
- ▶ Fencing boards should be carried in the middle and on their edge for best support when moving.
- ▶ Avoid sliding or dragging any equipment across the board surface to avoid tarnishing the surface.
- ▶ The surface of the fencing boards should be kept free of construction debris and material to prevent damage to the boards.

As with all sites, surfaces should be kept clean and tidy for the best installation outcome.

SAFETY AND USE

Prior to installing any composite system we recommended that you consult your local building control for any special regulations or restrictions that may apply. The illustrations and accompanying instructions in this guide are for illustrative purposes to provide a typical installation scenario, and do not replace the advice of a licensed professional in the field.

SAFETY

- ▶ Personal Protection Equipment (PPE) should be worn at all times (COSHH Assessment summary available). When cutting and installing boards it is advised to wear gloves, protective eye wear, a dust mask, long sleeves and trousers.
- ▶ Dry and windy environments may result in a naturally occurring static build-up in composite products. The level of static build up will not cause personal injury.

USE

- ▶ Standard tools can be used to install our composite fencing. When using a chop saw we would recommend a 60T+ Multipurpose Aluminium blade for maximum efficiency and neatness on cuts.
- ▶ Plan a layout for your fencing before starting to ensure the best looking layout is achieved.

TOOLS

Recommended tools to install Eurocell Eco Fencing system

Standard woodworking/fencing tools can be used when working with Eurocell Eco Fencing. If you are unsure on how to use any tool, please consult the tool's manufacturer's user manual:

- ▶ Stringline
- ▶ Tape measure
- ▶ Spirit Level
- ▶ Hole digging equipment
- ▶ Hand saw / Mitre saw
- ▶ Protective eye wear and relevant Personal Protection Equipment (PPE)
- ▶ Pencil
- ▶ Not essential but useful - Laser level and post hole digger
- ▶ Electric drill and cordless screwdriver when installing the fence base plates

PRE INSTALLATION INFORMATION

Installation of an Eco Fencing product is easy and straightforward. All of our products are compatible with recognised building and fencing materials. Eco Fencing can be sawn and fixed using traditional cutting tools. This easy to understand guide provides a detailed summary of installation.

- ▶ Installation must be carried out to the instructions provided. Eurocell hold no responsibility for incorrect or inferior installation.
- ▶ Failure to install in accordance to these instruction to these instructions will invalidate the product guarantee.
- ▶ Ground should be solid, stable, smooth. Do not install composite fencing on hollow or uneven areas.
- ▶ All Eco Fencing panels are not advised to exceed 6ft in height.



NOTE: Each job is different and for fences over 6ft tall a concrete grout should be poured down the posts to reduce the appearance of flex. The concrete grout can be added to any fence at any time if the flex is more than you wish.

Once erected Eco Fencing DOES NOT require maintenance for protection against rot and decay. It will weather naturally just like any other outdoor product.

Please note as we are replicating the characteristics of timber, products will vary in shade and grain effect. Some boards will have no grain and others will have grain effect, some products may also show the inner core material. All these effects are normal and part of the manufacturing process and in no way affect the longevity of Eco Fencing. Eco Fencing will fade naturally, as does timber, and this in no way will affect the longevity of the product

CLEANING AND CARE

Eurocell fencing boards will require periodic maintenance to remove the build up of dirt and debris. We recommend the fencing is cleaned once or twice a year using either:

- ▶ Washing with warm water and washing up liquid is sufficient for the product. Use a sponge rather than a pressure washer.

INSTALLATION METHODS

Eco Fencing is designed to fit in both complementary designed posts and existing posts. Eco Fencing is 52mm so it is designed to fit into existing posts.



ASSEMBLED FENCE HEIGHTS

Most fence posts in the UK are 6ft apart and this is the width we would recommend for fence panels.

Generally 6ft high is the maximum size fitted as planning usually dictates that 2m is the maximum before permission is required.

In all cases a professional option should be sought in the application and installation of the fence.



FENCING COMPONENTS

1.0

Please ensure you are familiar with all the fencing components prior to starting.

PRODUCT	SIZE	PROFILE
ECO FENCING BOARDS	6ft lengths graphite 52x300x1.828m 8ft lengths graphite 52x300x2.438m	
ECO FENCING POSTS	Eco Fence post 90x110x1800mm Eco Fence post with steel insert 90x110x2400mm 90x110x2700mm	
SHAPED TOPS	Eco Fence concave top 140x1830mm 140x2438mm Eco Fence convex top 140x1830mm 140x2438mm	
CORNER / 3-WAY UTILITY STRIP	58x20x2100mm	
DECORATIVE CAP		
ECO GATE		

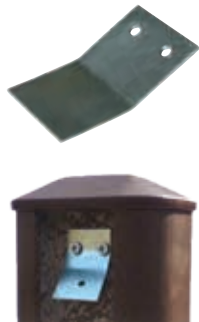
PRODUCT	SIZE	PROFILE
SUPASPIKE AND BOLT DOWN	Eco Fence bolt down 38x600mm (foot plate 150x150mm) Eco Fence supaspike 38x1080mm	
ANTI THEFT CLIP		

TECHNICAL DETAILS

POSTS

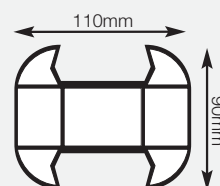

9ft Post 110 x 90 x 2743mm
8ft Post 110 x 90 x 2438mm
6ft Post 110 x 90 x 1829mm

GRAVEL BOARD

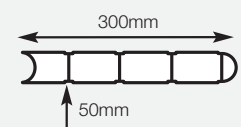

6ft Gravel Board
300 x 50 x 1829mm



2. PLANNING YOUR PROJECT

All fence panels are made to a standard 6ft (1.828m) width, and are usually available in four heights - 3ft (900mm), 4ft (1.2m), 5ft (1.52m) and 6ft (1.8m). If gravel boards are to be utilised, you should make an allowance of 1ft (300mm) when choosing panel heights. The posts are fitted in exactly the same as traditional timber or concrete posts with concrete mix in a 2ft deep hole.

Posts will be 2ft (600mm) longer than the actual fence height (including the gravel board if actually used). Eco Fencing posts should be concreted into the ground to ensure that the fence is sturdy. Allow 2ft (600mm) above the chosen fence height when deciding on post height. This extra 2ft (600mm) will be set below ground level in the concrete. Longer posts will be needed for sloping or soft ground.

3. MARKING OUT THE RUN

Establish the line of the fence by stretching a strong cord between stakes at the extremities of the run. Note that the posts should always be on your side of the boundary. Be sure to clear away any plants and vegetation along the line of the fence.

fig.1



4. MOUNTING THE FIRST POST

The first post will be the datum point for the complete run and therefore must be set accurately and upright. If the fence is running up to the house make sure the first post is securely attached to the building with wall anchors i.e. drilled and plugged. Be sure to insert these directly into the brickwork and not into the mortar.

fig.2

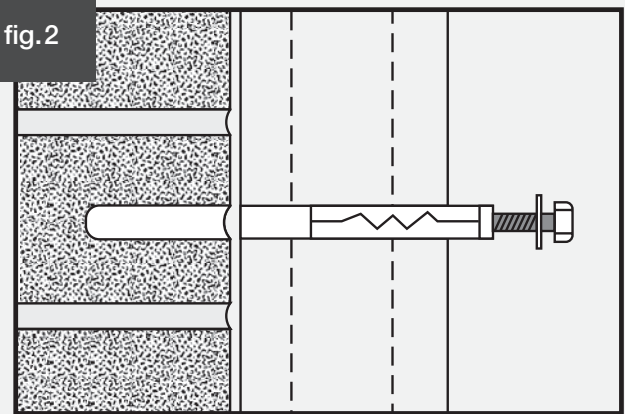

Anchors should be spaced no more than 2ft (0.6m) apart with no less than two in total. Drill the holes in the post first and allow only a small clearance over the shank diameter of the anchor bolt. Offer the post to the wall ensuring it is level in both vertical planes and aligned correctly (using a spirit level and engineers' square). If necessary use packing between the post and the wall.

Bolt the post firmly into position. If the first post is in open ground it will again need to be upright and perpendicular to the ground in both vertical planes and facing accurately in the correct direction. Mount in concrete as detailed below then attach to the first fence panel using 2.5" wood screws.

fig.3

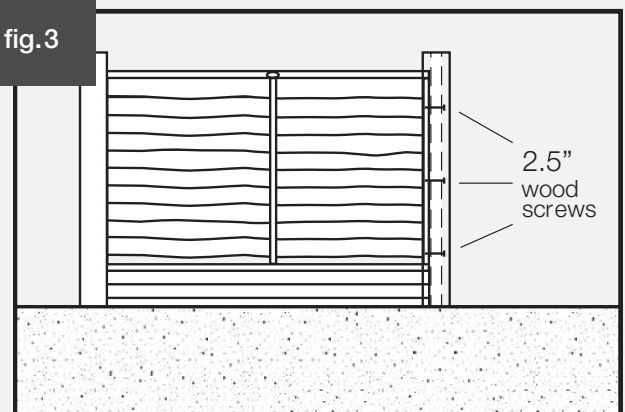

5. FIXING YOUR POSTS

Following the line you have marked, using either a post borer or spade, dig holes to accommodate the posts at a minimum depth of 26" (650mm). Pack the base of the hole with approximately 50mm of broken brick or stone hardcore to provide initial support for your post.

NOTE:- When installing the 2.4m and 2.7m eco posts it is vital that the steel insert inside the post is concreted into the ground, as the insert is 2m tall check before installation that the steel is in the ground.

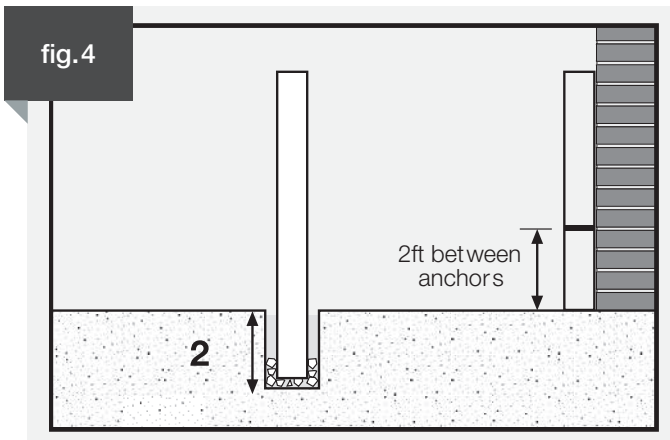

Utilising wooden braces for support as well as a spirit level, and square for positioning, pack with more hardcore around the bottom of the post leaving approximately 1ft (300mm) for further packing and concrete. When you are satisfied the post is level fill the hole with concrete.

You should allow a full 24 hours for the concrete to go off and set before removing the support braces. A good tip would be to use quick-drying concrete, which should save time and allow the fence to become permanent within a shorter space of time.

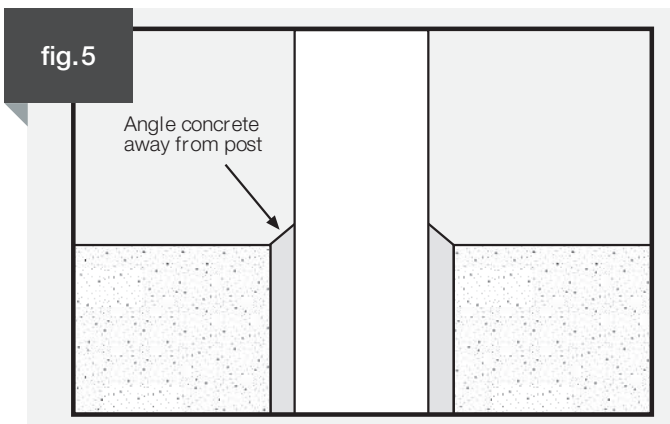

When finishing the concrete around the base of the post, angle the concrete away from the post to allow rainwater to drain away easily.

5. SECURING THE GRAVELBOARD AND FENCE PANEL

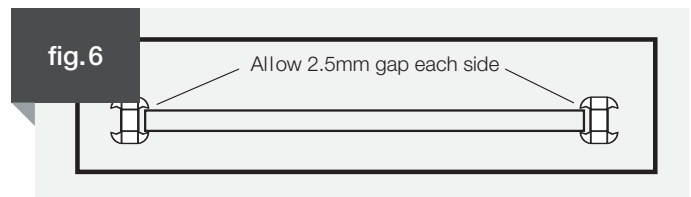

Place the gravel board into the 'H' slot of the post and align. The gravelboard may be sunk into the ground to provide a more secure fitting. Position your next post in place allowing a 2.5mm expansion gap at both ends of the gravelboard (use spacers).

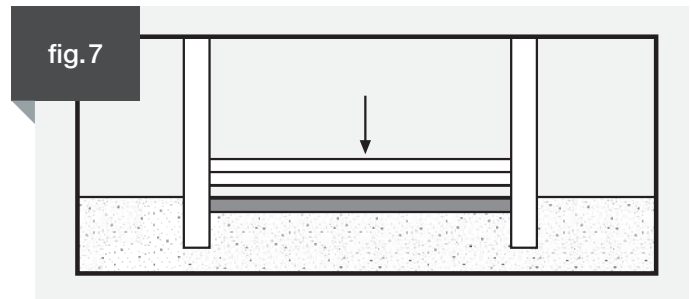

Secure the post as above, and finally, slot the fence panel between the two posts. If required, cut the posts down to size using standard cutting tools and complete by fitting decorative caps to posts.

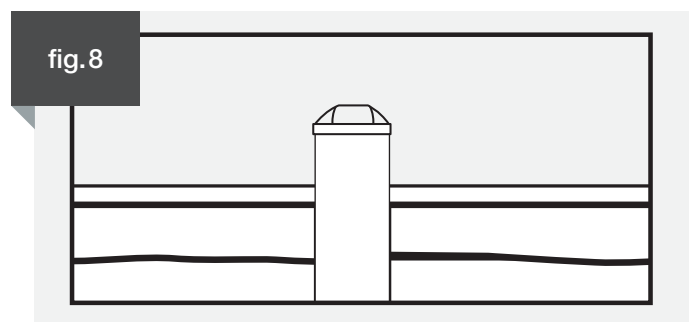

6. CREATING A FENCE ON A SLOPE

Essentially the methods above can be used to create a sloping fence. Cut your PVC gravel board to shape using standard cutting tools to provide a terrace effect. Longer fence posts may be required to compensate for the stepped panels (please refer to your local supplier). Where possible, attempt to spread the change as evenly as possible over the fence run to provide a more aesthetically pleasing finish.

fig.9

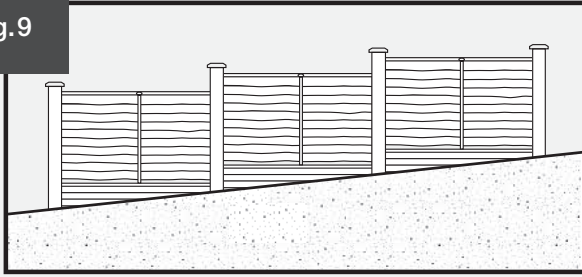

7. HANGING A GATE

In order to hang a gate a timber post can be fixed to the Eco post as shown in fig (10) below. The timber post must be concreted in alongside the Eco post to provide sufficient support for the gate.

A gate must never be just hung from an Eco post, it will not provide sufficient support for the gate. For gates' larger than 3ft w x 6ft h posts will need to be bigger.

fig.10

Timber post 100x100mm running full length of post to provide fixing for catches and bolts.

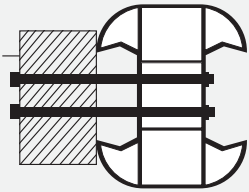

NOTE: that the 2.4m (8ft) boards are primarily used at the end of a fence run they can be cut down to size to suit the gap. Most fence posts in the UK are 6ft apart and this is the width we would recommend for fence panels. In all cases a professional option should be sought in the application and installation of the fence.

OPTION 1

INSTALLATION - RETROFIT



Eco Fencing is the perfect solution to replace rotten timber fence panels into existing concrete posts.

Simply remove the old timber fence panels, trim the Eco panels if necessary and stack on top of each other to the desired height. You can add a convex top to add extra height and style if you wish.



Please contact our Customer Care Team for additional support or advice:



0333 321 2353



eurocell.co.uk/technical-hub

eurocell.co.uk

